

## Quartz Crystal

SMD-version

model	KX – 5T
frequency	26,0 MHz
mode	fundamental
operating temperature	-40° ~ +85°C
frequency tolerance at +25°C	± 10 ppm
temperature tolerance -40° ~ +85°C	± 20 ppm
load capacitance $C_L$	12 pF
series resonance R1 max.	60 Ohm
aging at +25°C (first year) max.	± 2 ppm
shunt capacitance $C_0$ max.	3,5 pF
drive level	50 $\mu$ W typ., 100 $\mu$ W max.
contents of reel	1000 pcs.
part no.	12.85552

### Dimensions (mm):

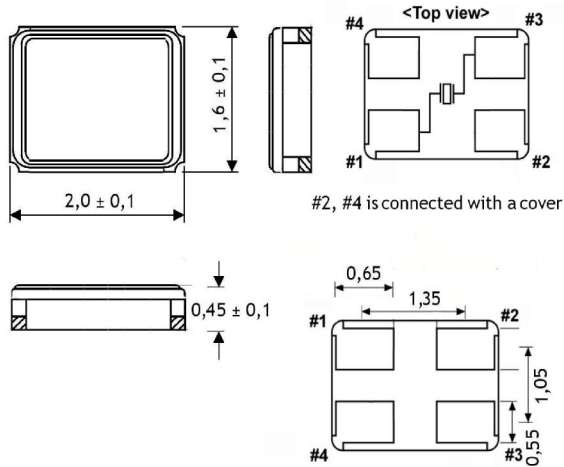

### Reflow soldering condition:

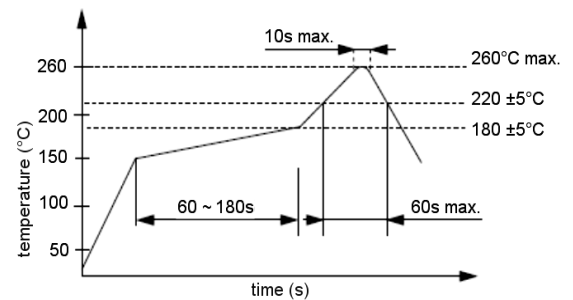

### Suggested soldering pad:

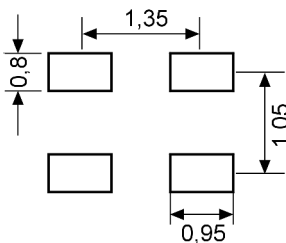

### Tape specification:

