



Quartz Crystal

SMD-version

model	KX – 12B
frequency	10,0 MHz
mode	fundamental
operating temperature	-20° ~ + 70°C
frequency tolerance at +25°C	± 30 ppm
temperature tolerance -20° ~ + 70°C	± 50 ppm
load capacitance C_L	16 pF
series resonance R_1 max.	80 Ohm
aging at 25°C (first year) max.	± 2 ppm
shunt capacitance C_O max.	7,0 pF
drive level in mW	0,05
contents of reel	1000 pcs.
RoHS	according to RoHS 2011/65/EU
part no.	12.87708

Dimensions (mm):

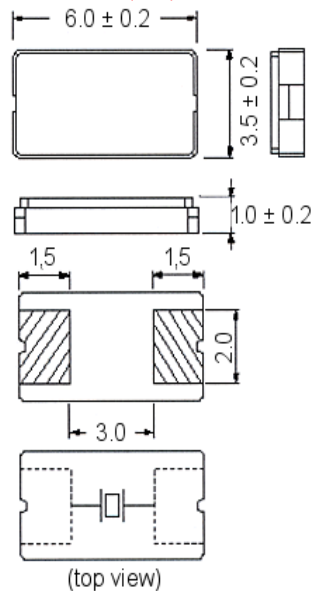

Suggested soldering pad:

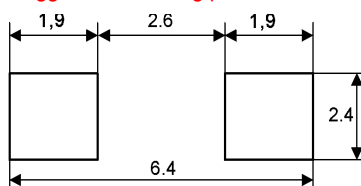

Reflow soldering condition:

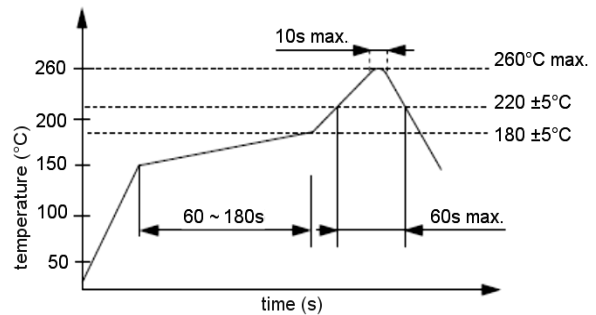

Tape specification:

