



## Quartz Crystal

SMD-version

model	KX - K
frequency	6,1440 MHz
mode	fundamental
operating temperature	-20° ~ + 70°C
frequency tolerance at +25°C	± 30 ppm
temperature tolerance at -20° ~ +70°C	± 50 ppm
load capacitance $C_L$	16 pF
series resonance R1 max.	60 Ohm
aging at 25°C (first year) max.	± 2 ppm
shunt capacitance $C_0$ max.	7,0 pF
drive level	0,1 mW
contents of reel	1000 pcs.
part no.	12.87844

**Dimensions (mm):**

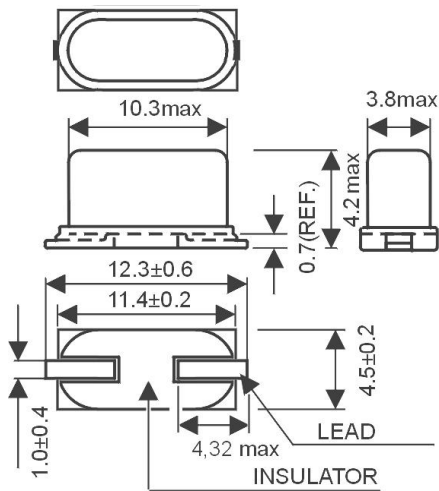

**Suggested soldering pad:**

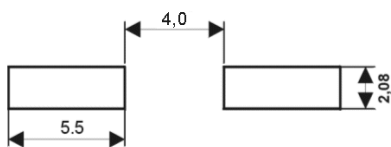

**Reflow soldering condition:**

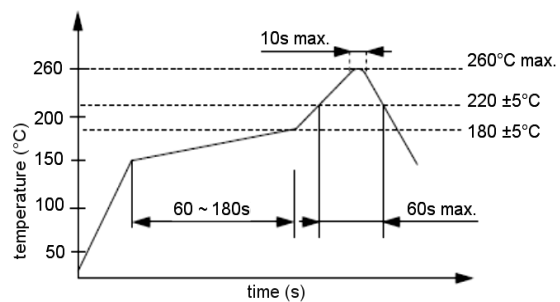

**Tape specification:**

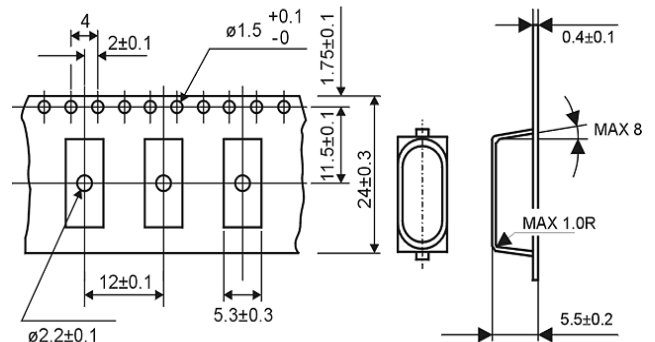

reel diameter 330 mm